

medium cloud mast · installation guide

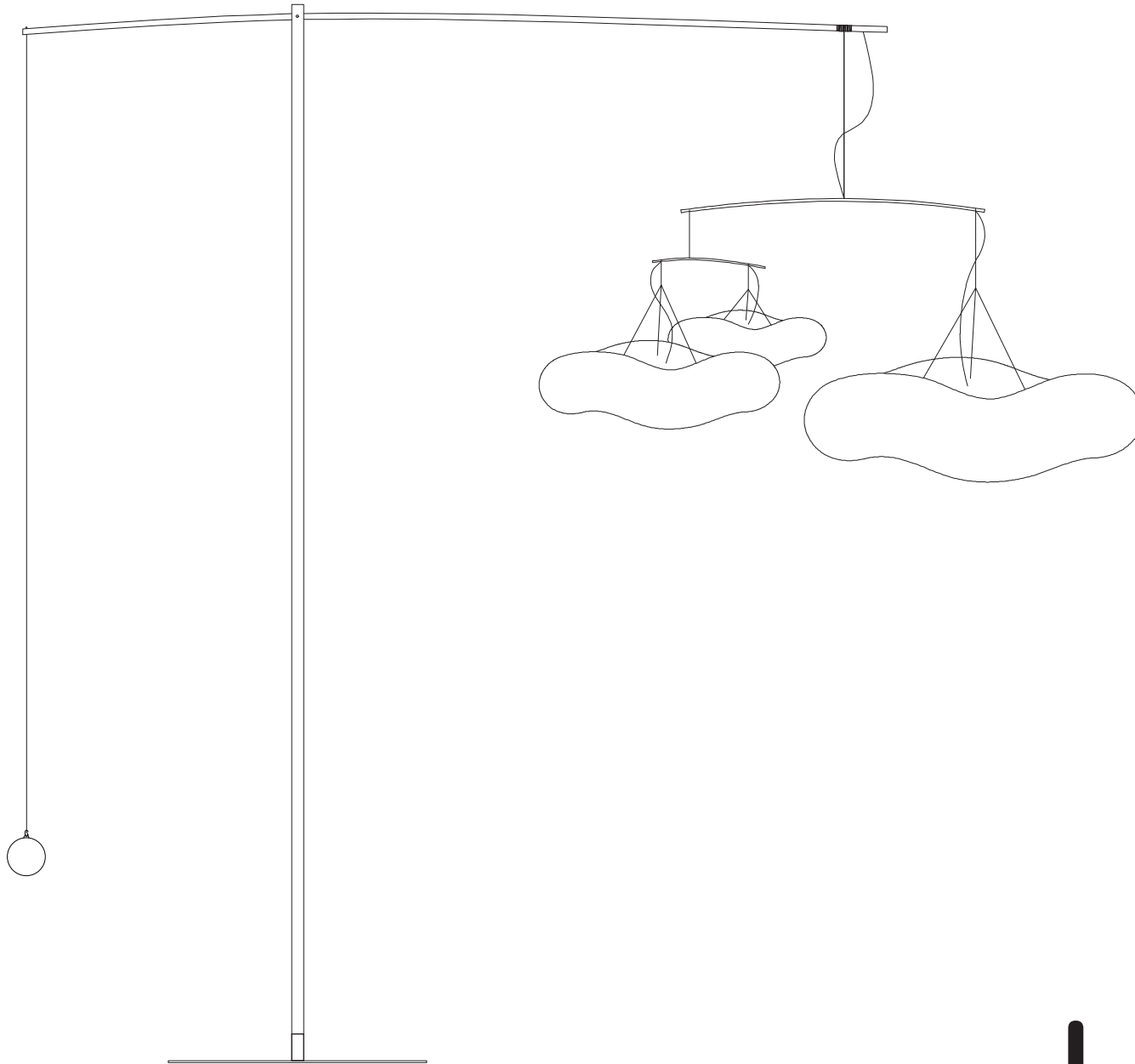

molo

medium cloud mast anatomy

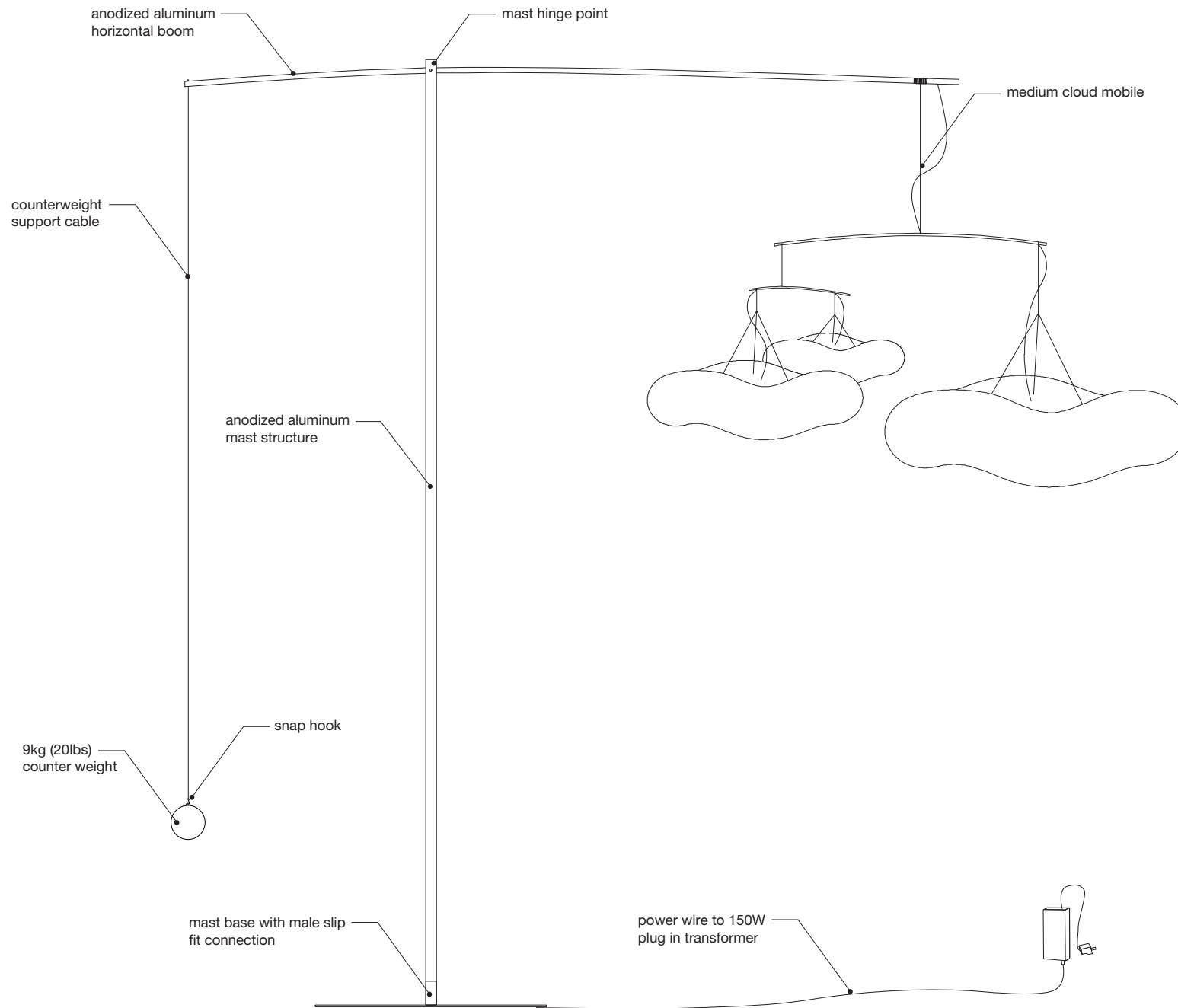

medium cloud mobile anatomy

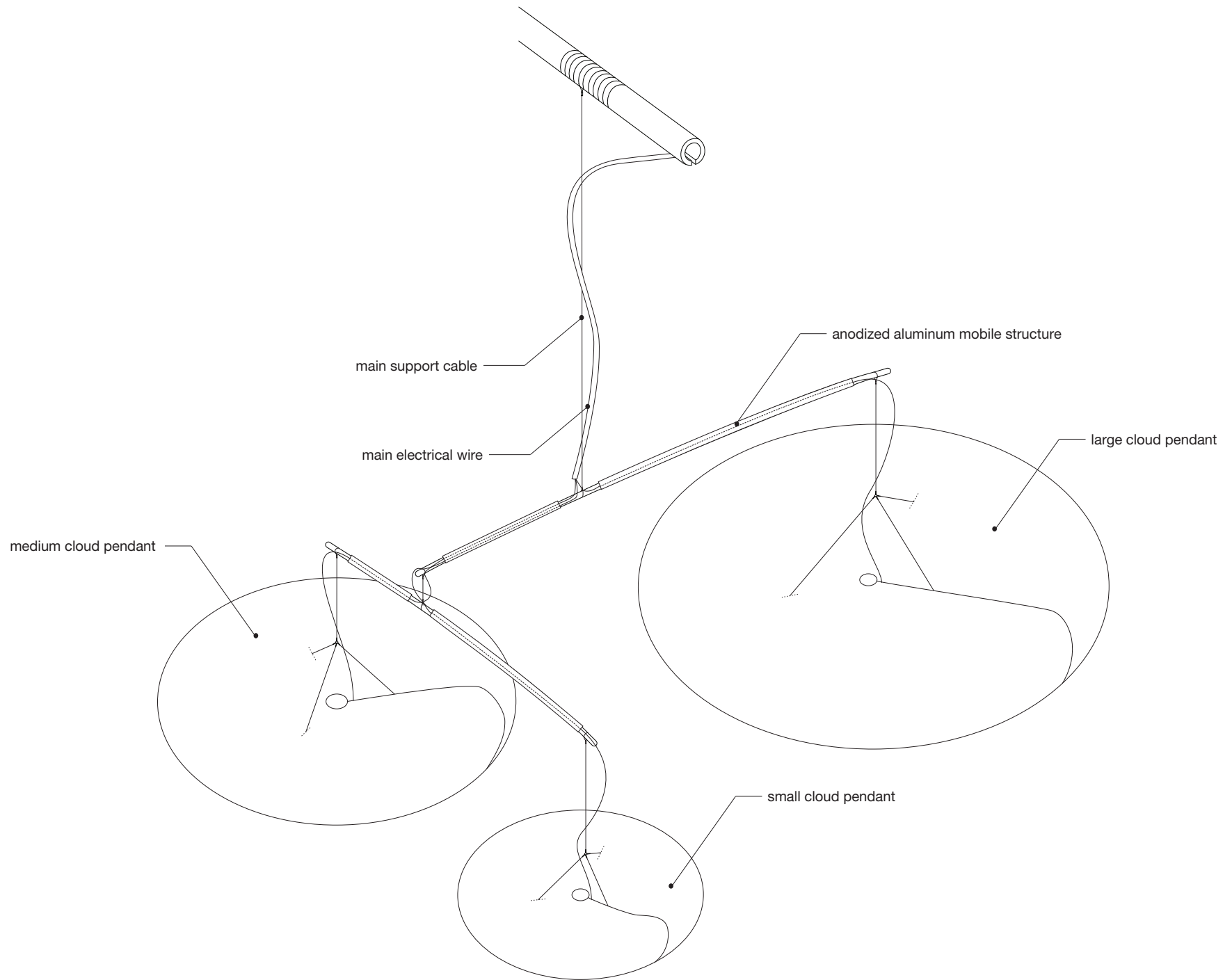

anatomy of cloud pendant within mobile

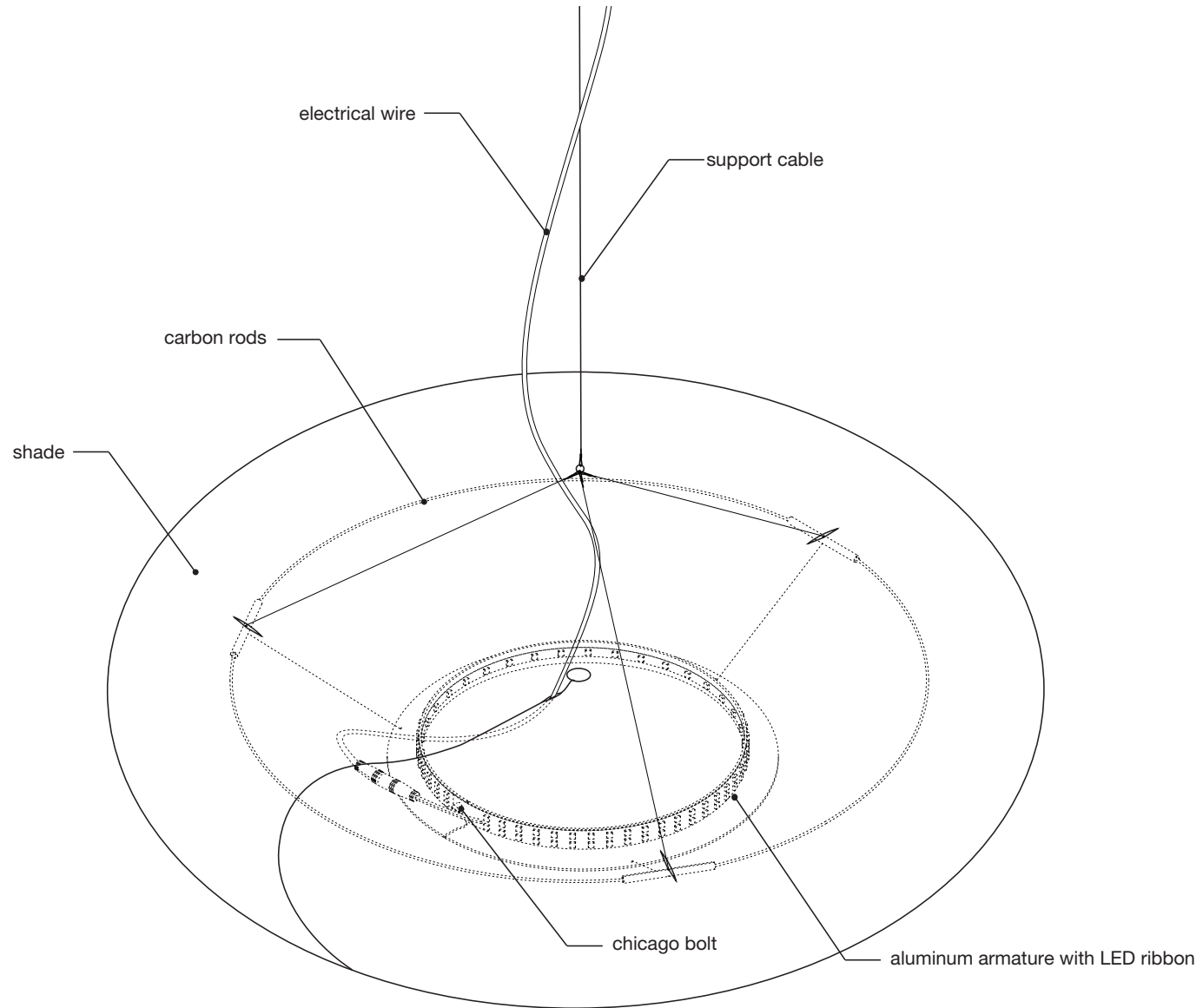

medium cloud mast parts

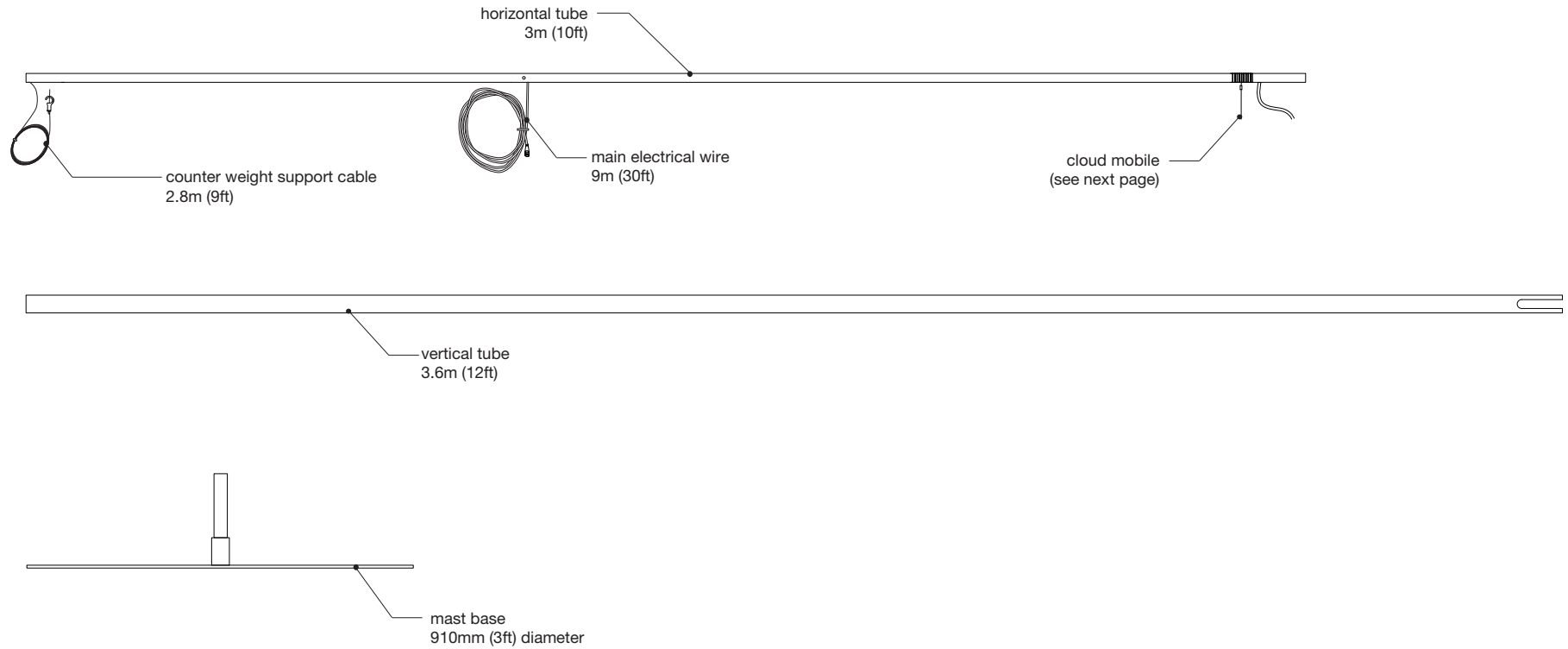

1x 9kg (20lbs) counter weight with snap hook



mast hinge pin with nylon sieve



2x knurled thumb nuts

medium cloud mobile parts

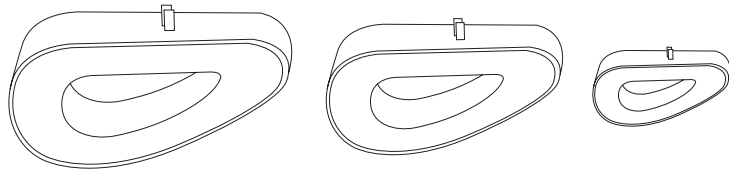
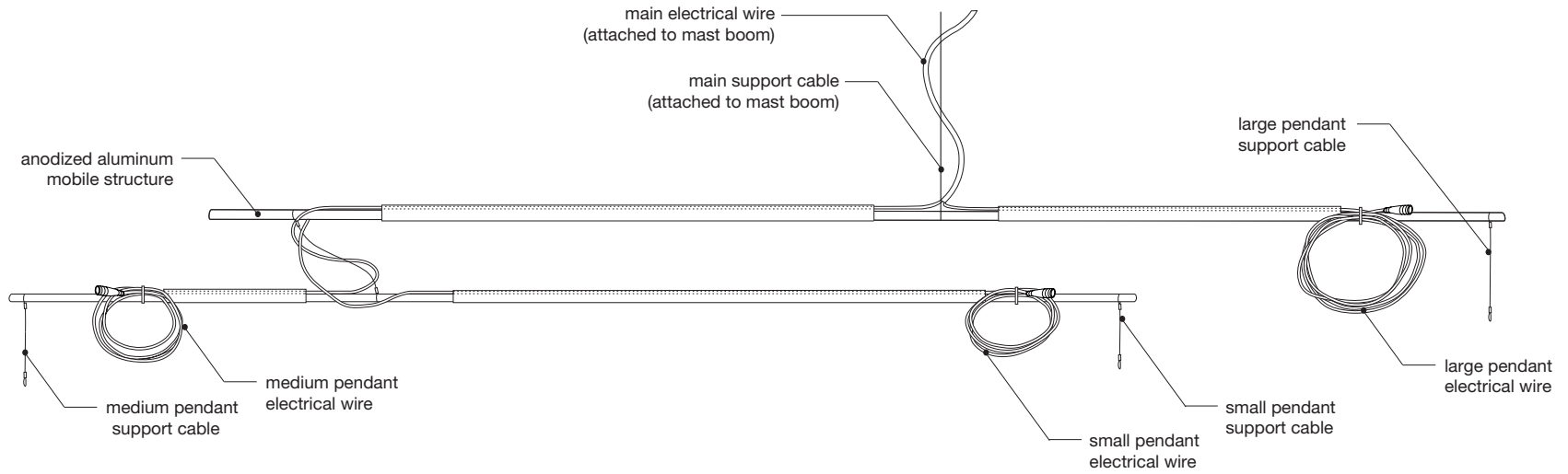

cloud shade
sm, md, lg
(compressed for shipping)

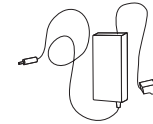

plug-in transformer

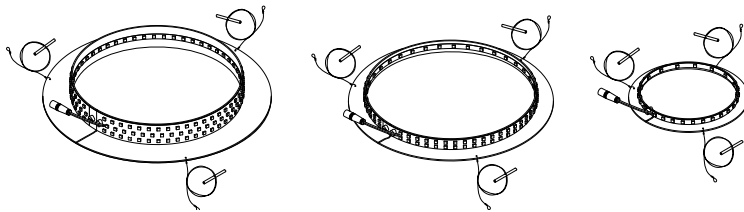

shade armatures
+ LEDs
sm, md, lg



split ring pliers



sets of 3 carbon
rods
sm, md, lg

medium cloud mast assembly

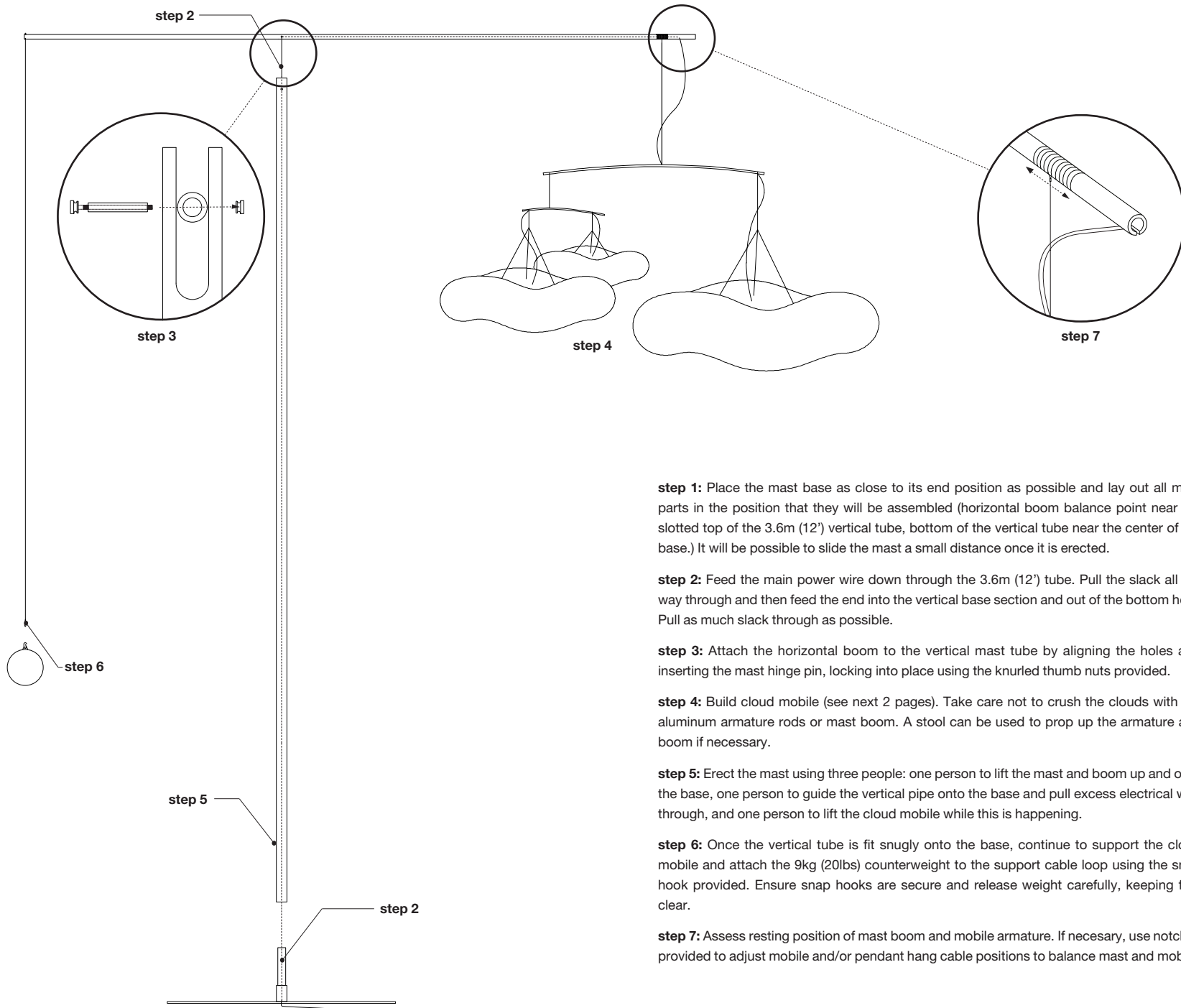

step 1: Place the mast base as close to its end position as possible and lay out all mast parts in the position that they will be assembled (horizontal boom balance point near the slotted top of the 3.6m (12') vertical tube, bottom of the vertical tube near the center of the base.) It will be possible to slide the mast a small distance once it is erected.

step 2: Feed the main power wire down through the 3.6m (12') tube. Pull the slack all the way through and then feed the end into the vertical base section and out of the bottom hole. Pull as much slack through as possible.

step 3: Attach the horizontal boom to the vertical mast tube by aligning the holes and inserting the mast hinge pin, locking into place using the knurled thumb nuts provided.

step 4: Build cloud mobile (see next 2 pages). Take care not to crush the clouds with the aluminum armature rods or mast boom. A stool can be used to prop up the armature and boom if necessary.

step 5: Erect the mast using three people: one person to lift the mast and boom up and onto the base, one person to guide the vertical pipe onto the base and pull excess electrical wire through, and one person to lift the cloud mobile while this is happening.

step 6: Once the vertical tube is fit snugly onto the base, continue to support the cloud mobile and attach the 9kg (20lbs) counterweight to the support cable loop using the snap hook provided. Ensure snap hooks are secure and release weight carefully, keeping feet clear.

step 7: Assess resting position of mast boom and mobile armature. If necessary, use notches provided to adjust mobile and/or pendant hang cable positions to balance mast and mobile.

cloud pendant assembly

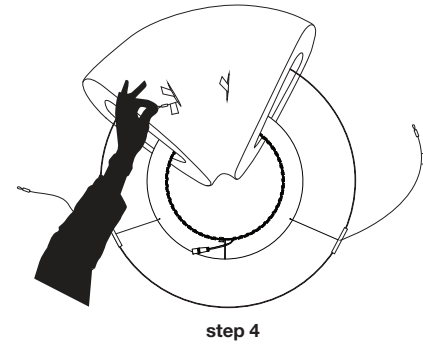
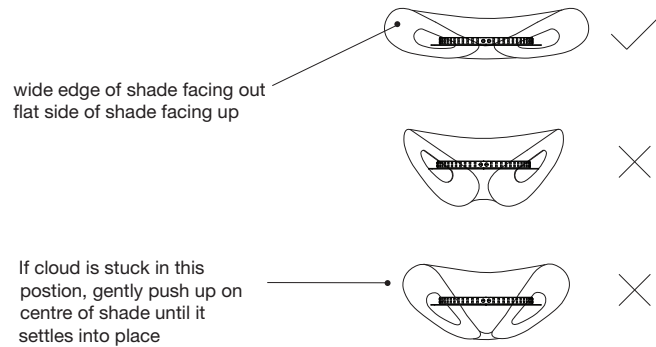
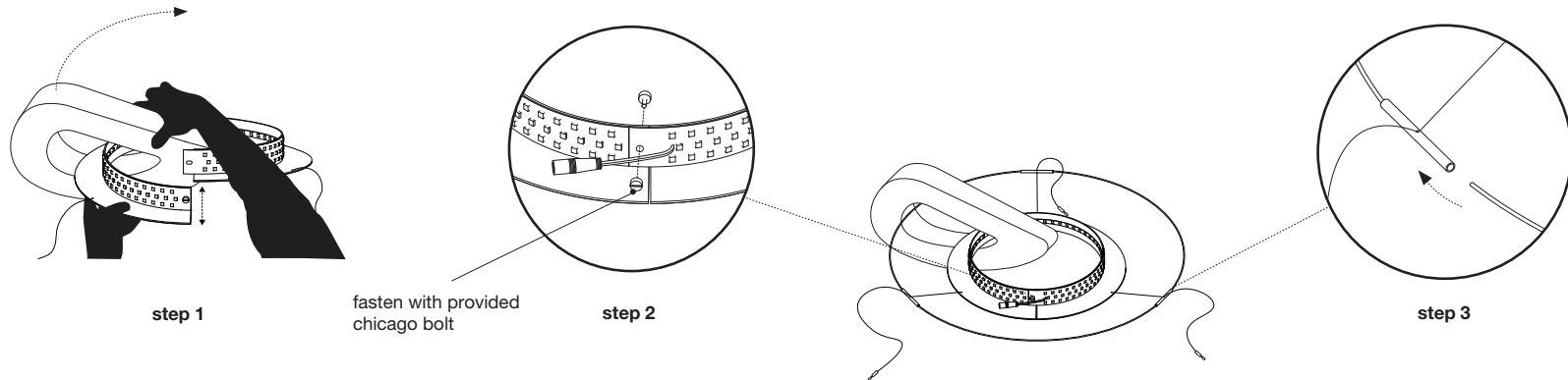

step 1: Start with the medium cloud shade. Undo the chicago bolt and split the angle ring LED armature by pulling the open ends of the ring apart vertically. Thread the armature through the cloud shade with the horizontal flange facing down. Make sure the flat side of the shade is facing up and the wider end of the shade is facing outwards.

IMPORTANT: If this step is not done correctly the cloud will look “droopy” when installed. The cloud should sit relatively flat and undulate gently when installed correctly.

step 2: Close armature ring and fasten through hole in LED ribbon and aluminium ring using provided chicago bolt.

step 3: Complete the outer ring of the armature by inserting the white painted carbon rods into the aluminum tube connectors (fixed to cables). The rods will flex to create a circle inside the cavity of the shade.

step 4: Feed two of the three support cables through the larger cells of the shade. Make sure the red tagged wire passes through the red tagged cell and the blue tagged wire passes through the blue tagged cell. **Remove tags.**

cloud pendant assembly

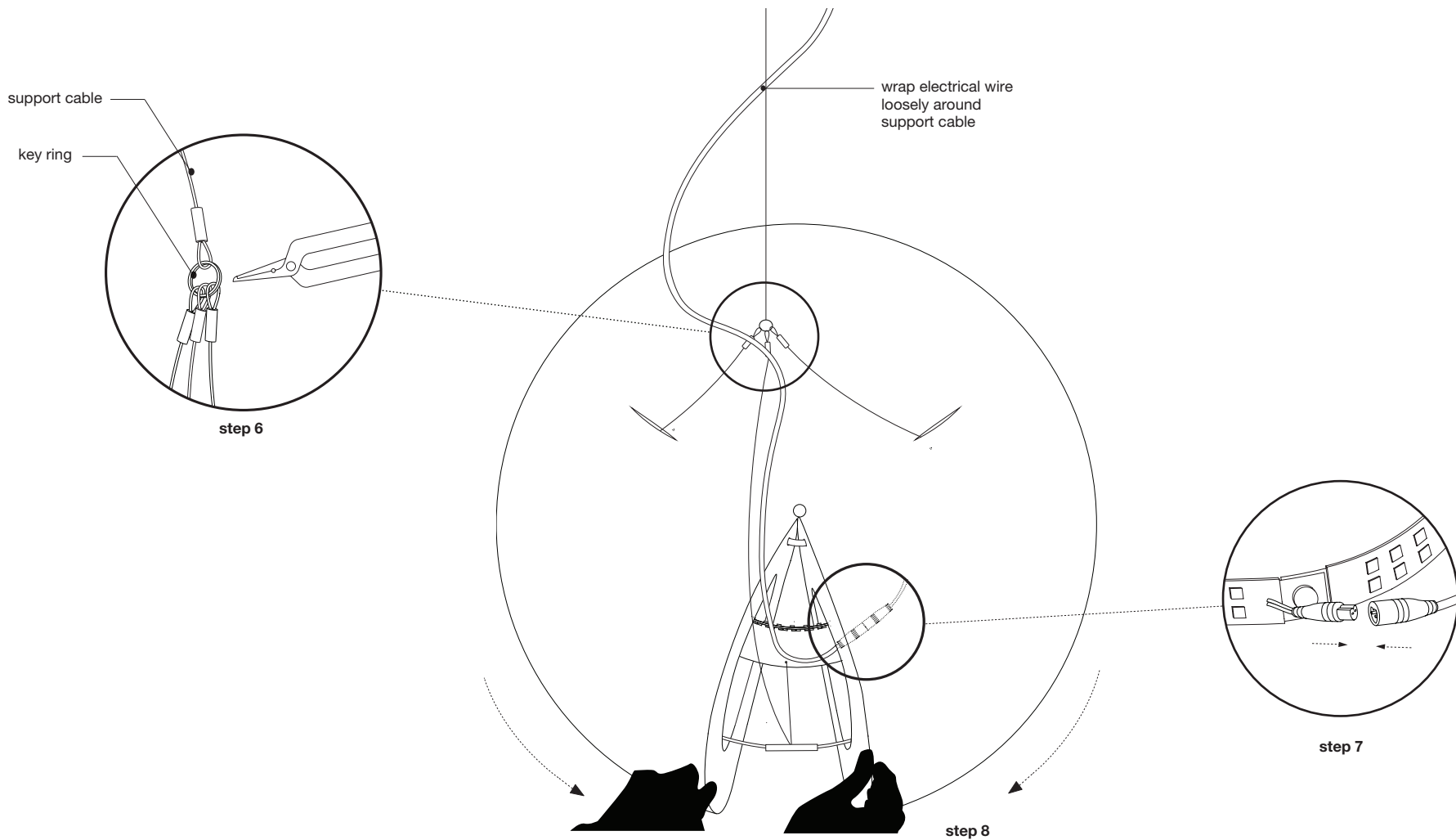

step 6: Use split ring pliers to open the key ring attached to main support cable and attach the three support cables from cloud pendant.

step 7: Wrap electrical wire loosely around support cable and then connect it to LED ribbon inside shade (be sure to line up matching groove in male and female ends of clear connectors).

step 8: Close the shade around the armature by grabbing 20+ layers of the outer fins and pulling the magnetic end panels around the ring until they connect together. The third steel support cable and electrical wire should be sandwiched between the two closed magnetic end panels.

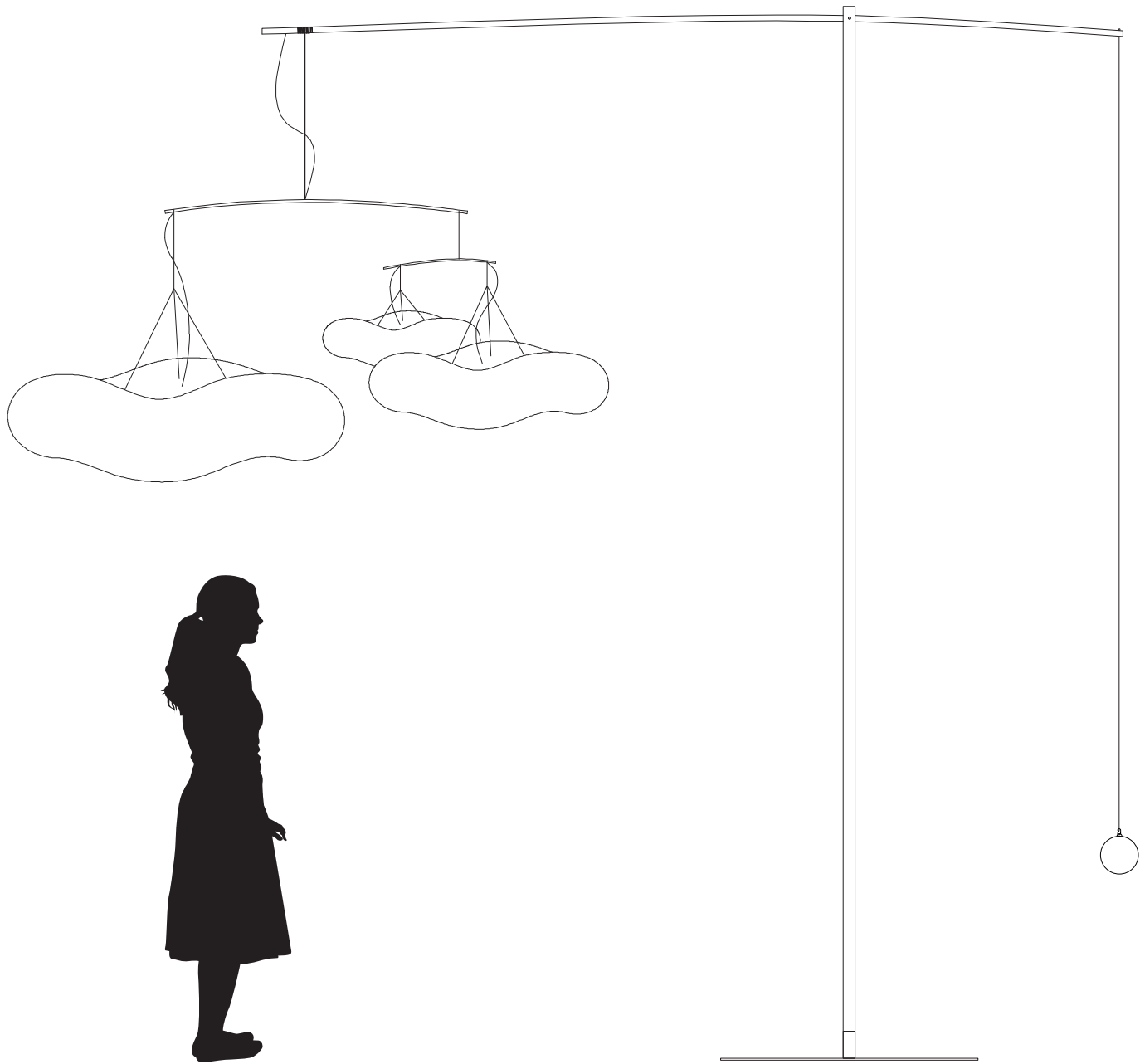

ENERGY LABEL
 ENERGIJA
 энергия · ενεργεια

A ⁺⁺	
A ⁺	▶
A	▶
B	▶
C	▶
D	▶
E	▶

82 kWh/1000h