

molo

medium cloud mobile anatomy

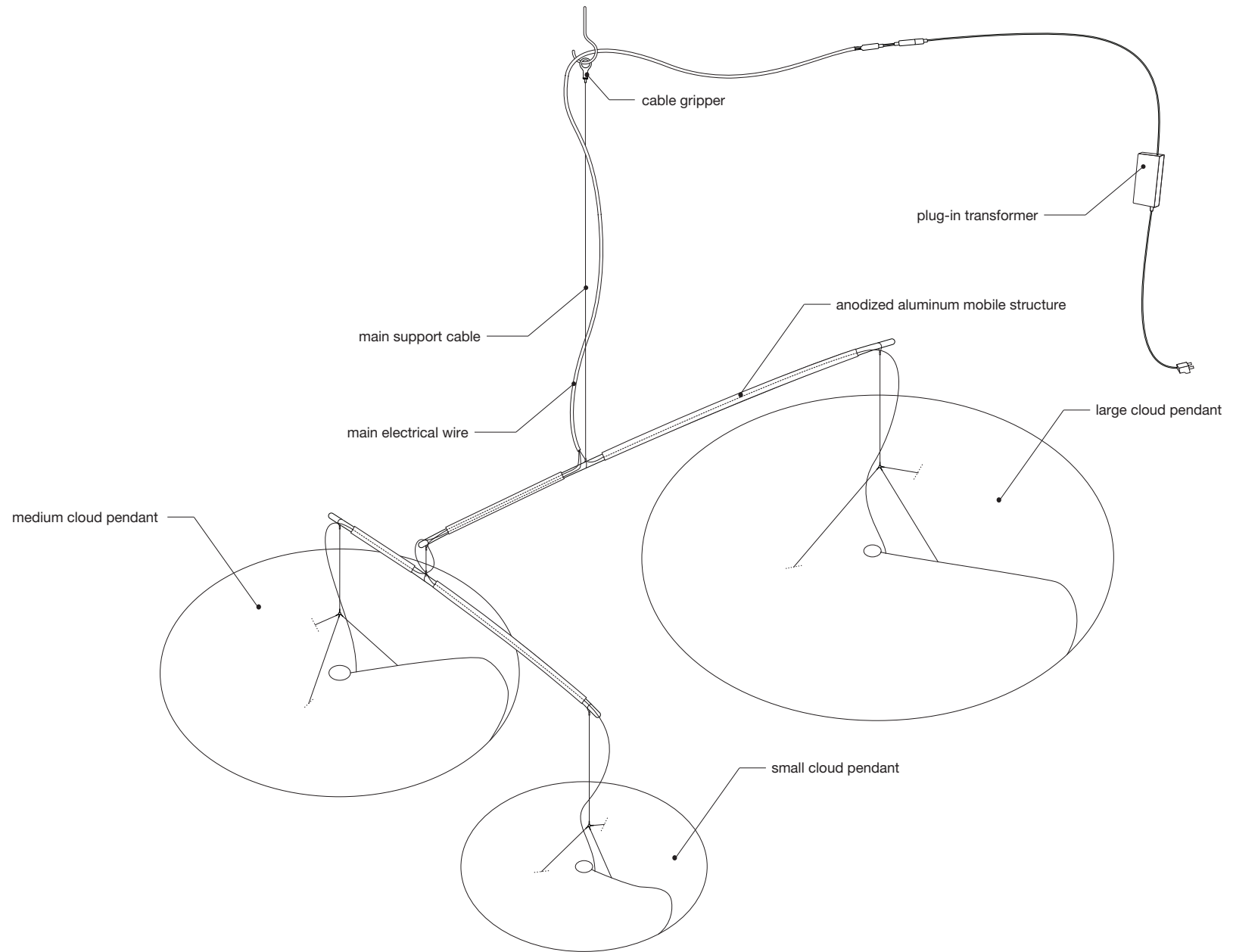

medium cloud mobile parts

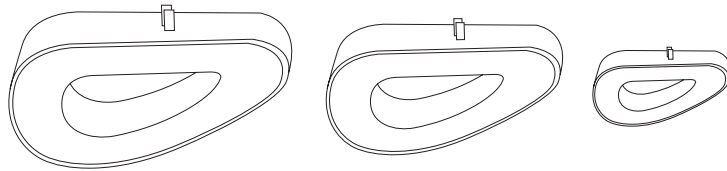
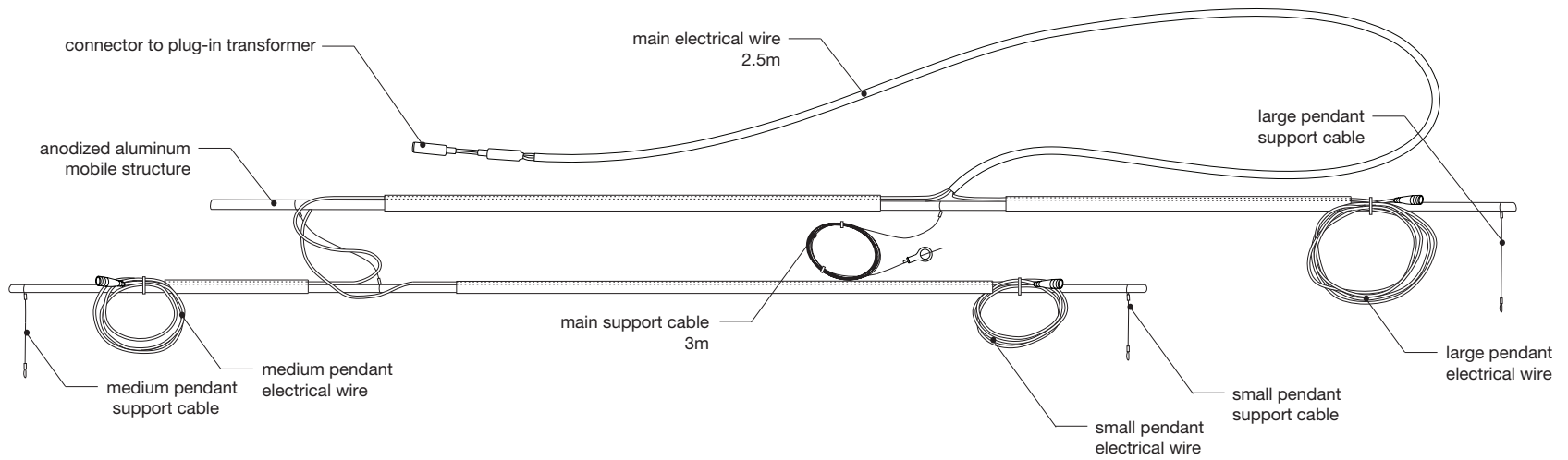

cloud shade
sm, md, lg
(compressed for shipping)

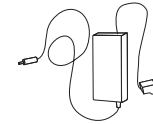

plug-in transformer

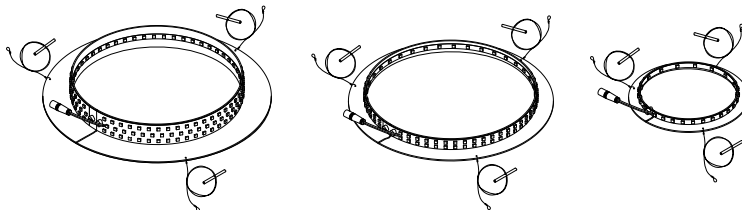

shade armatures
+ LEDs
sm, md, lg



split ring pliers

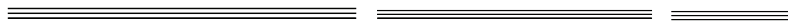

sets of 3 carbon
rods
sm, md, lg

anatomy of cloud pendant within mobile

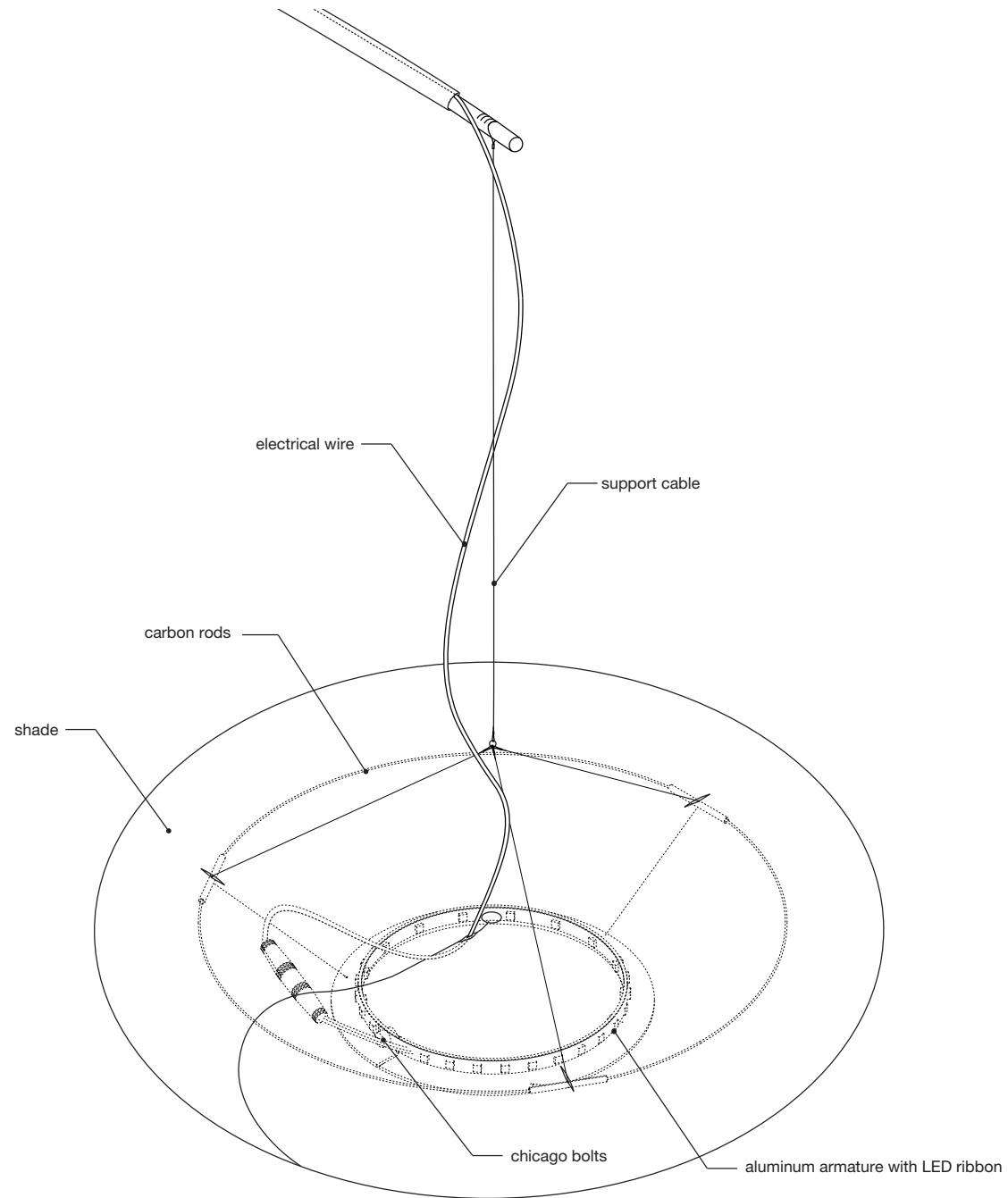

cloud pendant assembly

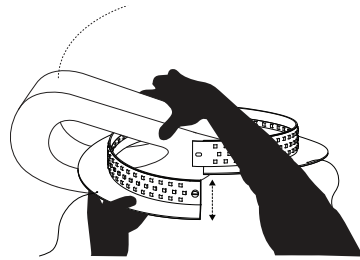

step 1

fasten with provided
chicago bolt

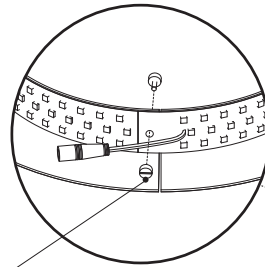

step 2

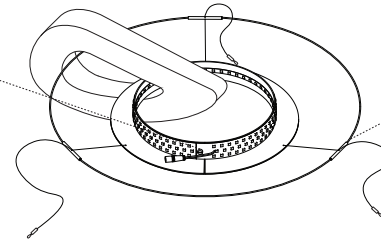

step 3

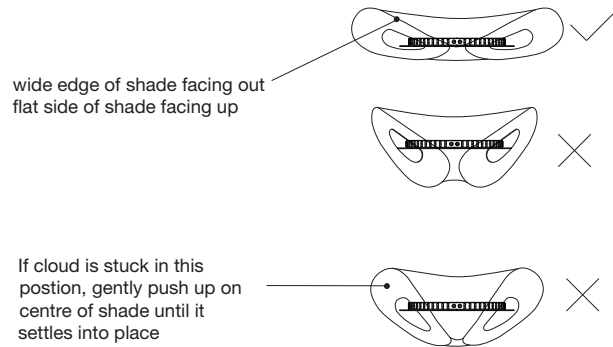

wide edge of shade facing out
flat side of shade facing up

If cloud is stuck in this
position, gently push up on
centre of shade until it
settles into place

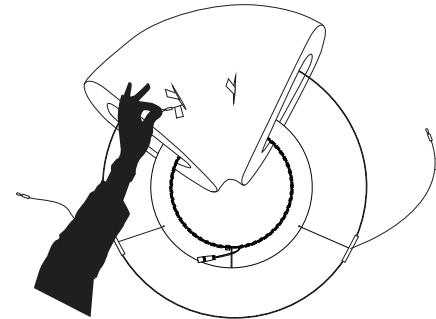

step 4

step 1: Undo the chicago bolt and split the angle ring LED armature by pulling the open ends of the ring apart vertically. Thread the armature through the cloud shade with the horizontal flange facing down. Make sure the flat side of the shade is facing up and the wider end of the shade is facing outwards.

IMPORTANT: If this step is not done correctly the cloud will look “droopy” when installed. The cloud should sit relatively flat and undulate gently when installed correctly.

step 2: Close armature ring and fasten through hole in LED ribbons and aluminium ring using provided chicago bolt.

step 3: Complete the outer ring of the armature by inserting the white painted carbon rods into the aluminum tube connectors (fixed to cables). The rods will flex to create a circle inside the cavity of the shade.

step 4: Feed two of the three support cables through the larger cells of the shade. Make sure the red tagged wire passes through the red tagged cell and the blue tagged wire passes through the blue tagged cell. **Remove tags.**

cloud pendant assembly

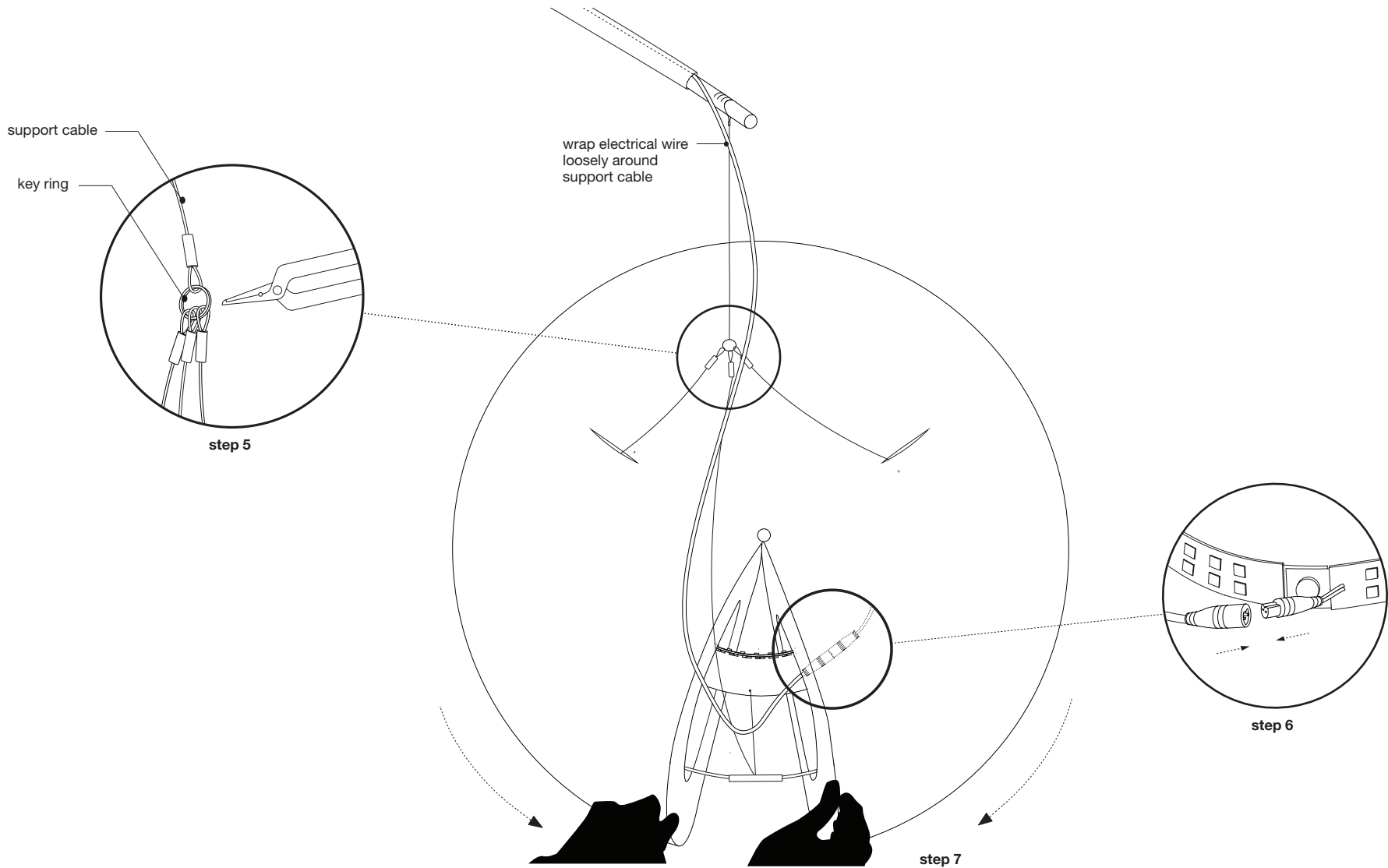

step 5: Use split ring pliers to open the key ring attached to main support cable and attach the three support cables from cloud pendant armature.

step 6: Connect electrical wire to LED ribbon inside shade (be sure to line up matching groove in male and female ends of clear connectors).

step 7: Close the shade around the armature by grabbing 20+ layers of the outer fins and pulling the magnetic end panels around the ring until they connect together. The third steel support cable and electrical wire should be sandwiched between the two closed magnetic end panels.

medium cloud mobile installation

step 8

push up on cable gripper to allow support cable to pass through

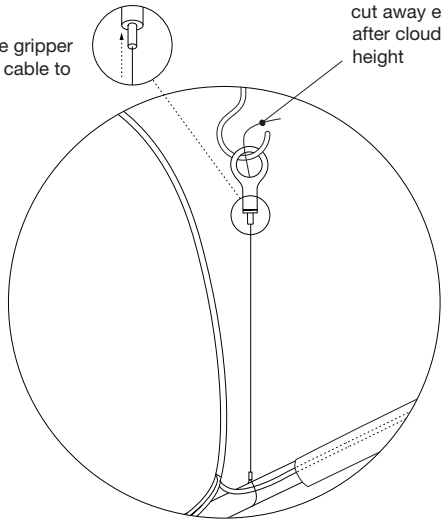

cut away excess support cable after cloud mobile is set to desired height

hanging method must support 6.0kg weight of cloud mobile (hook not included)

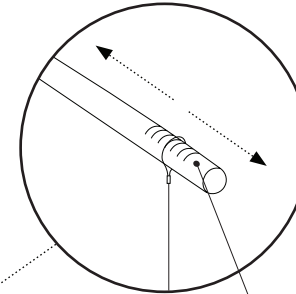

step 10

if mobile is unbalanced, adjust balance by moving pendant support cables along notches in aluminum bars of mobile armature

step 9

wrap electrical wire loosely around support cable and connect to transformer after height of cloud mobile is set

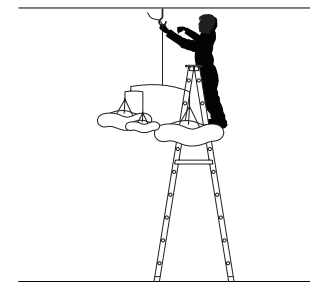

lift mobile and hang from cable gripper

